

CVC Words

Beginning and Ending Sounds Letter U

Directions: Say the name of each picture. Then fill in the missing beginning and ending sounds to form the words.

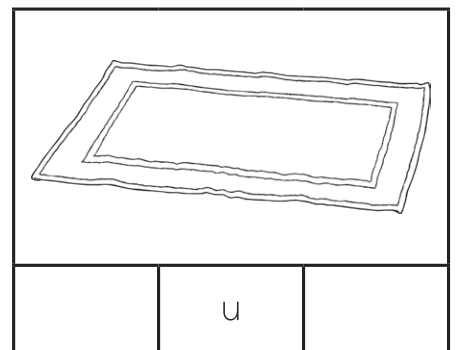
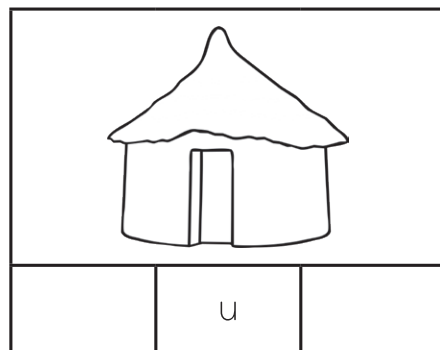
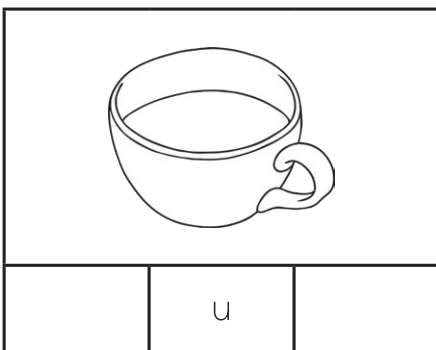
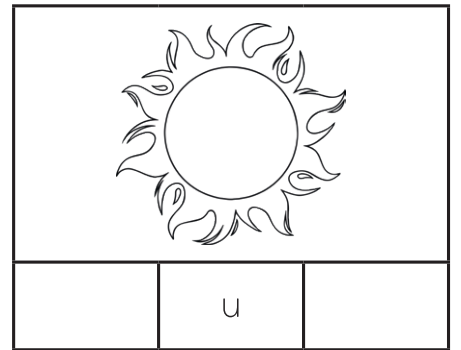
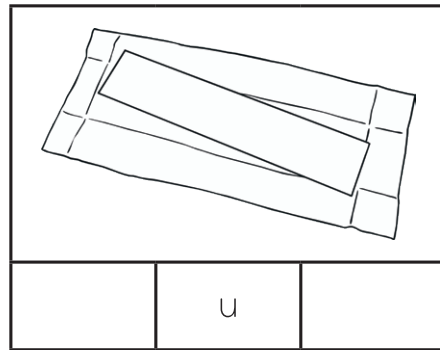
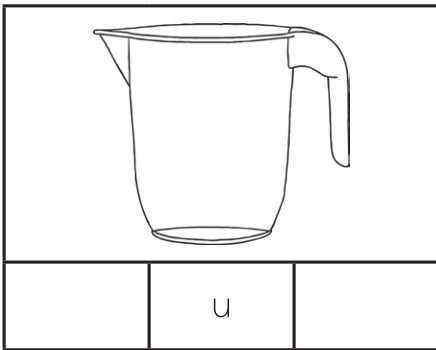
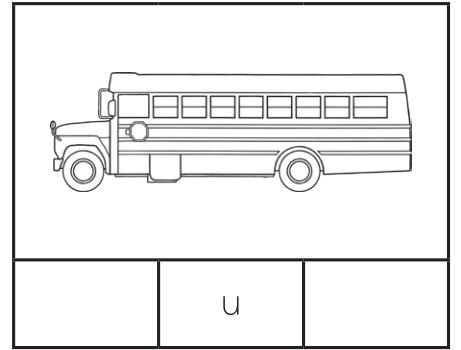
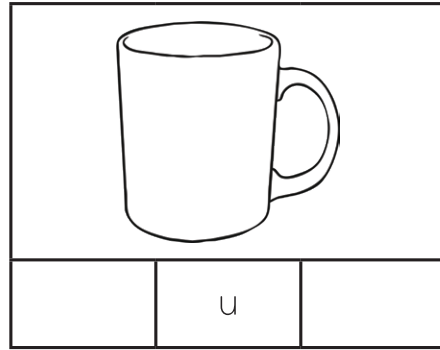
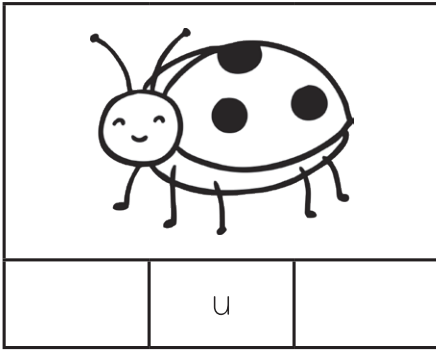

CVC Words

Beginning and Ending Sounds Letter U Answers

